

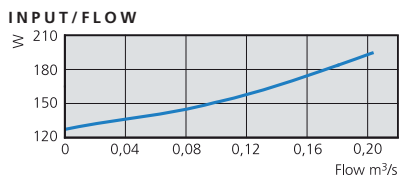

# DFE 133-2 DFE 133-4

Double inlet radial fan with forward curved impeller. Single phase

## DFE 133-2

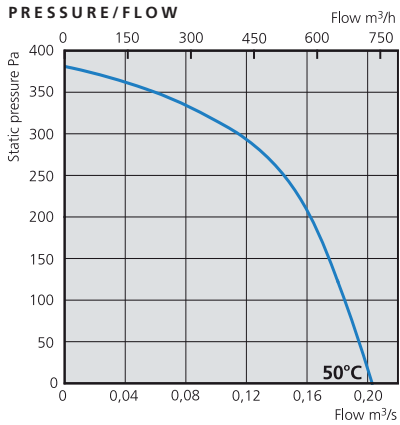

### TECHNICAL DATA

Voltage, V/Hz	230/50
Current, A	0,84
Input, W	194
Speed, rpm	1570
Wiring diagram	4040001
Capacitor, µF	5
Max.temp. °C	50
Insulation class	F
Motor protection	IP 44

### ACCESSORIES

Flange

### DIMENSIONS (mm)

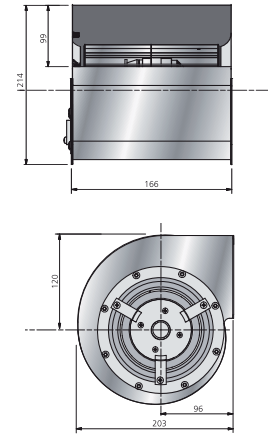

### SOUND DATA

DFE 133-2, 145 l/s 245 Pa	L <sub>pA</sub>	L <sub>wA</sub> tot dB (A)	63	125	250	500	1K	2K	4K	8K
Environment	63	70	39	46	57	62	65	66	63	56
Outlet		76	56	61	55	58	71	72	70	65

General fan facts, page 30-31.

## DFE 133-4

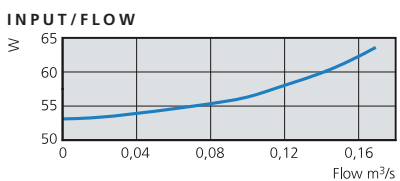
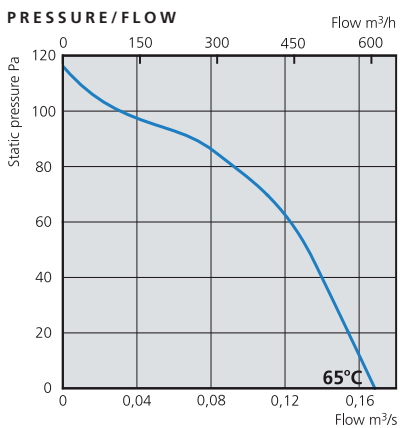

### TECHNICAL DATA

Voltage, V/Hz	230/50
Current, A	0,28
Input, W	63
Speed, rpm	1120
Wiring diagram	4040001
Capacitor, µF	2
Max.temp. °C	65
Insulation class	F
Motor protection	IP 44

### ACCESSORIES

Flange

### DIMENSIONS (mm)

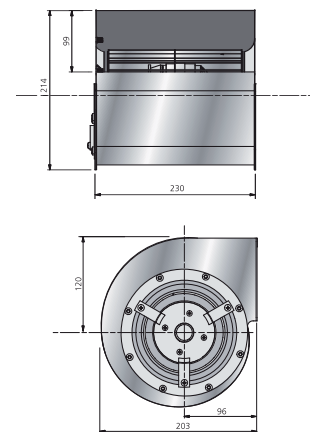

### SOUND DATA

DFE 133-4, 100 l/s 75 Pa	L <sub>pA</sub>	L <sub>wA</sub> tot dB (A)	63	125	250	500	1K	2K	4K	8K
Environment	49	56	34	37	43	49	54	50	44	40
Outlet		61	48	50	43	48	59	55	48	38

General fan facts, page 30-31.

# DFE 133-20

# DFE 133-21

Double inlet radial fan with forward curved impeller. Single phase



## DFE 133-20

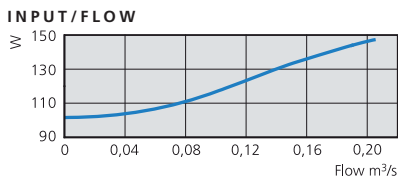
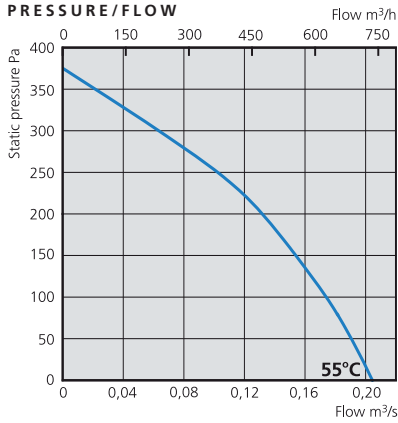

### TECHNICAL DATA

Voltage, V/Hz	230/50
Current, A	0,64
Input, W	147
Speed, rpm	1144
Wiring diagram	4040001
Capacitor, µF	4
Max.temp. °C	55
Insulation class	F
Motor protection	IP 44

### ACCESSORIES

Flange

### DIMENSIONS (mm)

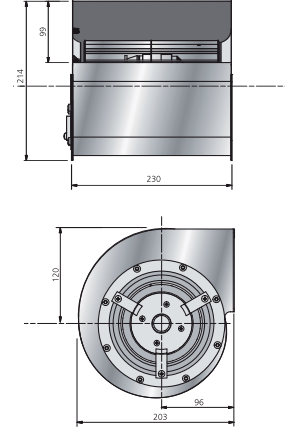

### SOUND DATA

DFE 133-20, 125 l/s 215 Pa	L <sub>pA</sub>	L <sub>WA</sub> tot dB (A)	63	125	250	500	1K	2K	4K	8K
Environment	59	66	43	49	54	58	62	61	57	50
Outlet		73	56	58	54	58	71	67	64	57

General fan facts, page 30-31.

## DFE 133-21

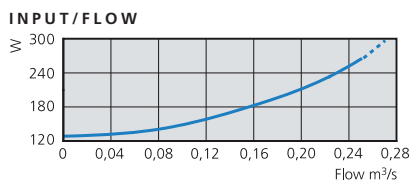
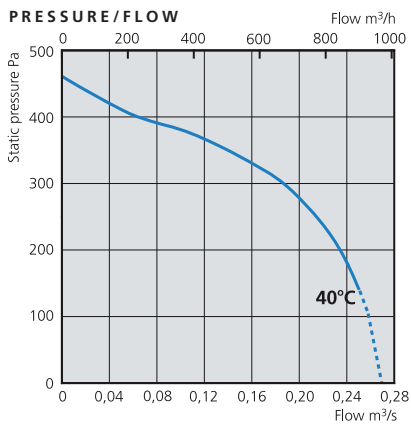

### TECHNICAL DATA

Voltage, V/Hz	230/50
Current, A	1,15
Input, W	264
Speed, rpm	2000
Wiring diagram	4040001
Capacitor, µF	5
Max.temp. °C	40
Insulation class	F
Motor protection	IP 44

### ACCESSORIES

Flange

### DIMENSIONS (mm)

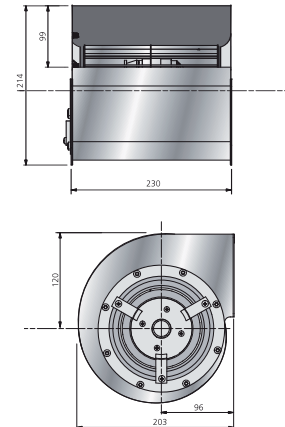

### SOUND DATA

DFE 133-21, 185 l/s 305 Pa	L <sub>pA</sub>	L <sub>WA</sub> tot dB (A)	63	125	250	500	1K	2K	4K	8K
Environment	64	71	48	52	61	63	65	66	64	57
Outlet		77	59	62	59	62	73	73	70	65

General fan facts, page 30-31.



# DFE 133-22

# DFE 133-23

Double inlet radial fan with forward curved impeller. Single phase

## DFE 133-22

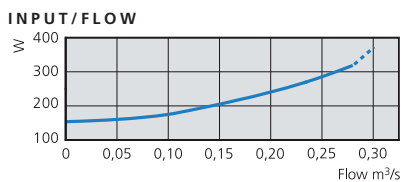
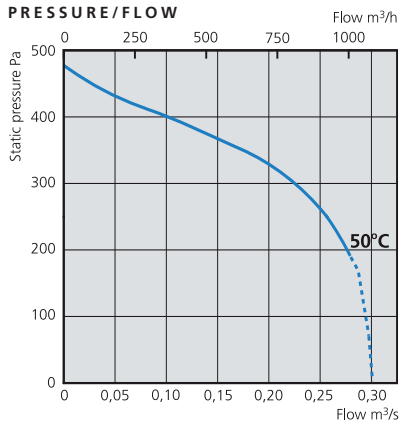

### TECHNICAL DATA

Voltage, V/Hz	230/50
Current, A	1,38
Input, W	317
Speed, rpm	2356
Wiring diagram	4040001
Capacitor, $\mu$ F	8
Max.temp. $^{\circ}$ C	50
Insulation class	F
Motor protection	IP 44

### ACCESSORIES

Flange

### DIMENSIONS (mm)

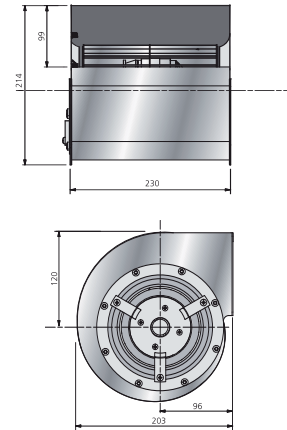

### SOUND DATA

DFE 133-22, 215 l/s 315 Pa	$L_{pA}$	$L_{WA}$ tot dB (A)	63	125	250	500	1K	2K	4K	8K
Environment	66	73	44	48	61	65	66	69	66	61
Outlet		80	57	60	59	64	75	77	73	69

General fan facts, page 30-31.

## DFE 133-23

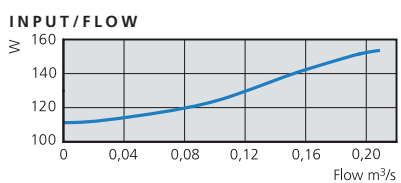
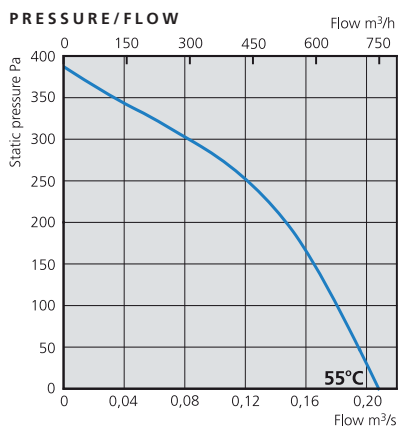

### TECHNICAL DATA

Voltage, V/Hz	230/50
Current, A	0,67
Input, W	153
Speed, rpm	1216
Wiring diagram	4040001
Capacitor, $\mu$ F	5
Max.temp. $^{\circ}$ C	55
Insulation class	F
Motor protection	IP 44

### ACCESSORIES

Flange

### DIMENSIONS (mm)

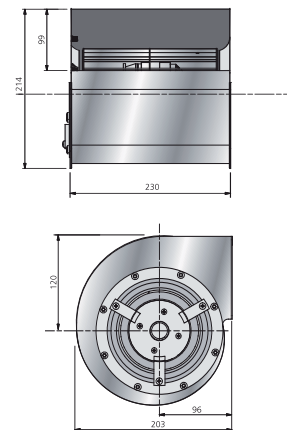

### SOUND DATA

DFE 133-23, 135 l/s 225 Pa	$L_{pA}$	$L_{WA}$ tot dB (A)	63	125	250	500	1K	2K	4K	8K
Environment	60	67	45	49	54	58	62	59	51	
Outlet		73	57	60	54	58	70	68	65	58

General fan facts, page 30-31.

# DFE 133-24

# DFE 146-S2

Double inlet radial fan with forward curved impeller. Single phase



## DFE 133-24

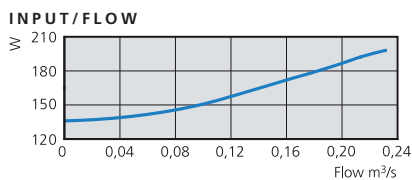
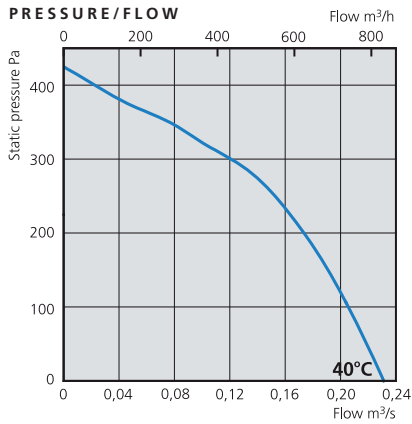

### TECHNICAL DATA

Voltage, V/Hz	230/50
Current, A	0,85
Input, W	195
Speed, rpm	1308
Wiring diagram	4040001
Capacitor, µF	5
Max.temp. °C	40
Insulation class	F
Motor protection	IP 44

### ACCESSORIES

Flange

### DIMENSIONS (mm)

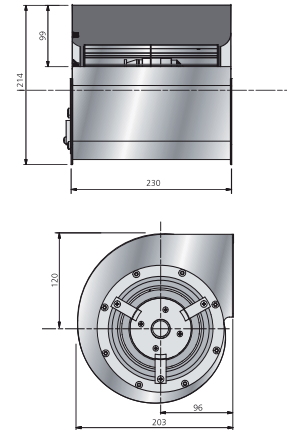

### SOUND DATA

DFE 133-24, 140 l/s 270 Pa	L <sub>pA</sub>	L <sub>WA</sub> tot dB (A)	63	125	250	500	1K	2K	4K	8K
Environment	61	68	44	50	57	60	63	64	61	54
Outlet		76	57	61	56	60	73	71	67	62

General fan facts, page 30-31.

## DFE 146-S2

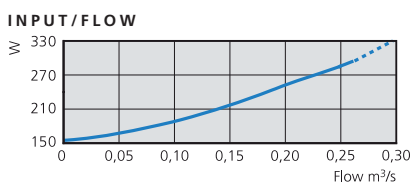
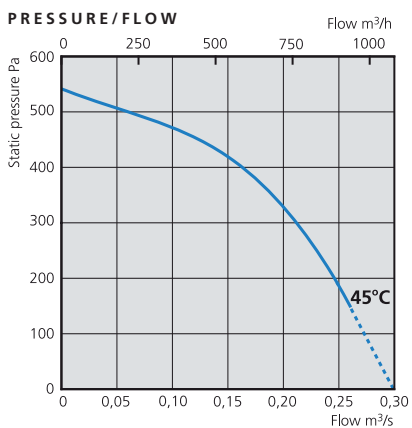

### TECHNICAL DATA

Voltage, V/Hz	230/50
Current, A	1,3
Input, W	290
Speed, rpm	1950
Wiring diagram	4040001
Capacitor, µF	10
Max.temp. °C	45
Insulation class	F
Motor protection	IP 44

### DIMENSIONS (mm)

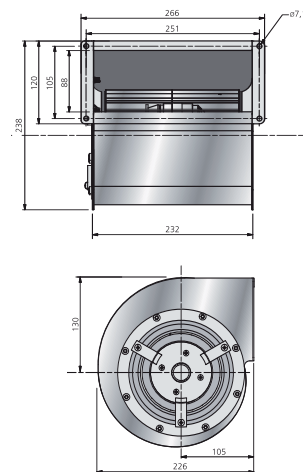

### SOUND DATA

DFE 146-S2, 180 l/s 385 Pa	L <sub>pA</sub>	L <sub>WA</sub> tot dB (A)	63	125	250	500	1K	2K	4K	8K
Environment	65	72	52	57	64	66	66	67	64	58
Outlet		76	58	64	62	64	72	72	70	66

General fan facts, page 30-31.



# DFE 146-S4

Double inlet radial fan with forward curved impeller. Single phase

## DFE 146-S4

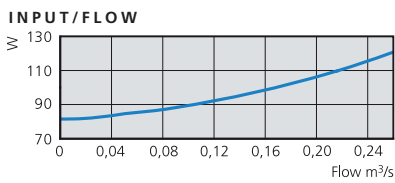
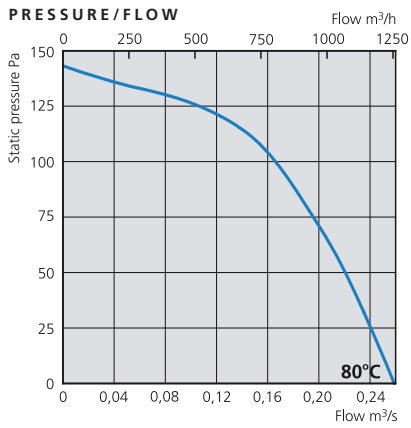

### TECHNICAL DATA

<b>Voltage, V/Hz</b>	230/50
<b>Current, A</b>	0,53
<b>Input, W</b>	121
<b>Speed, rpm</b>	1287
<b>Wiring diagram</b>	4040001
<b>Capacitor, µF</b>	5
<b>Max.temp. °C</b>	80
<b>Insulation class</b>	F
<b>Motor protection</b>	IP 44

### DIMENSIONS (mm)

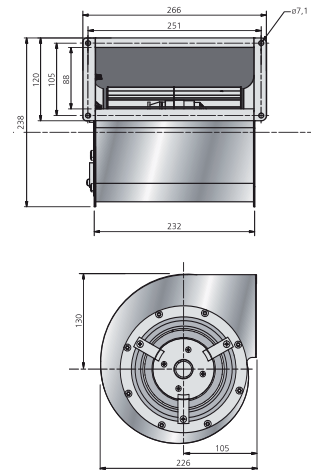

### SOUND DATA

DFE 146-S4, 160 l/s 105 Pa	$L_{pA}$	$L_{WA}$ tot dB (A)	63	125	250	500	1K	2K	4K	8K
Environment	55	62	34	43	53	55	58	56	52	43
Outlet		65	49	57	56	51	62	58	54	45

General fan facts, page 30-31.